

CHUBB

JOHN TANN

LIPS

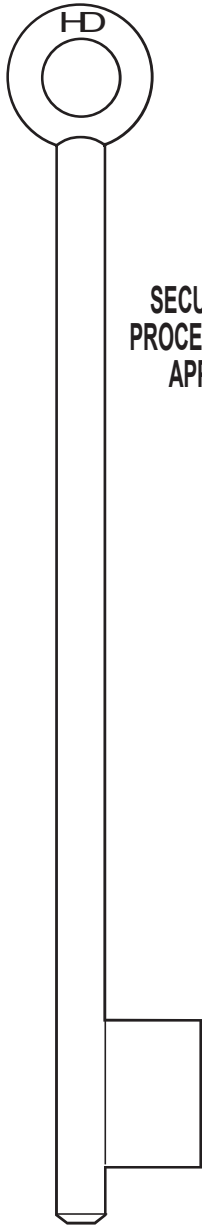

SECURITY
PROCEDURES
APPLY

For Chubb 4.5" Pin Safe



KBCH1(3g) KBCH2(5g)

L318 L319

MATERIAL	STEEL
GAUGE	3 or 5
FINISH	N/P

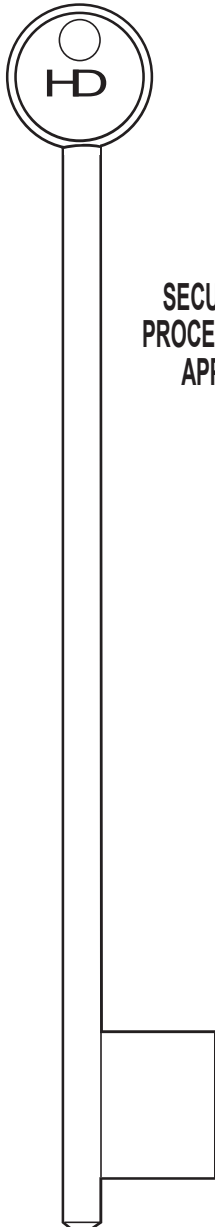

SECURITY
PROCEDURES
APPLY

For John Tann 4.5"



KBTAN

L320

MATERIAL	STEEL
GAUGE	6.5
FINISH	N/P

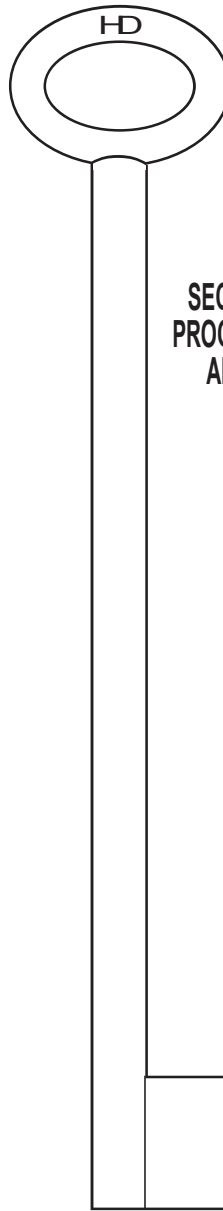

SECURITY
PROCEDURES
APPLY

Key blanks supplied
with smallest gauge.
Re-drill as necessary.

For long Lips Pipe Safe



KBLIP1

L312

MATERIAL	STEEL
GAUGE	10 PIPE
FINISH	N/P

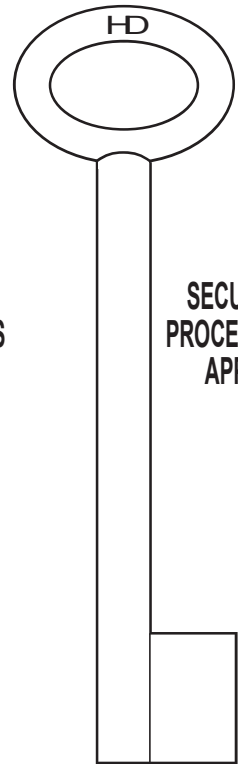

SECURITY
PROCEDURES
APPLY

Key blanks supplied
with smallest gauge.
Re-drill as necessary.

For medium Lips Pipe Safe



KBLIP2

L313

MATERIAL	STEEL
GAUGE	10 PIPE
FINISH	N/P

LIPS

SLS

SMP

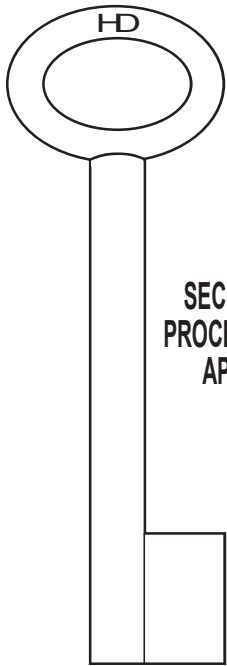

SECURITY
PROCEDURES
APPLY

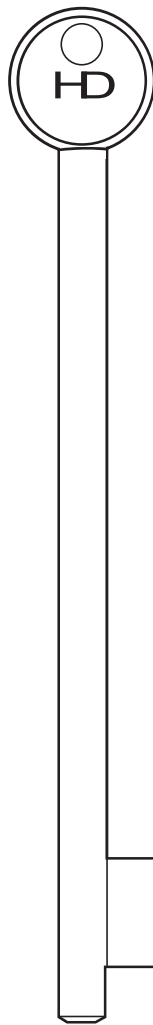

SECURITY
PROCEDURES
APPLY

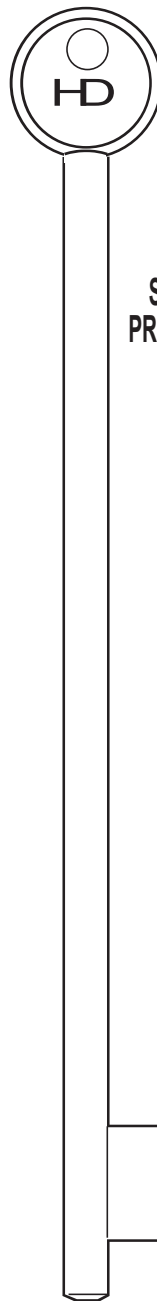

SECURITY
PROCEDURES
APPLY

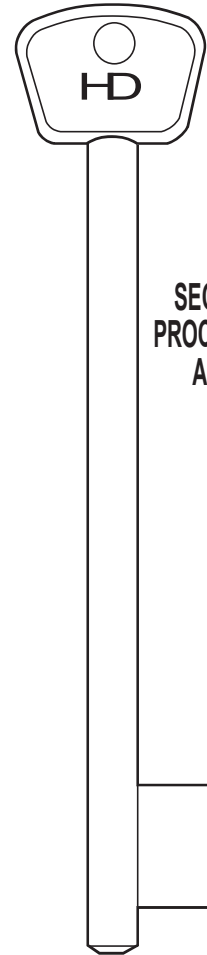

SECURITY
PROCEDURES
APPLY

Key blanks supplied with smallest gauge. Re-drill as necessary.

For short Lips Pipe Safe

For SLS 3.5/8"

For SLS 5"

For SMP 3.5"



KBLIP3

L314

MATERIAL	STEEL
GAUGE	10 PIPE
FINISH	N/P



KBSLS2

L317

MATERIAL	STEEL
GAUGE	3
FINISH	N/P



KBSLS1

L316

MATERIAL	STEEL
GAUGE	3
FINISH	N/P



KBSMP3

L325

MATERIAL	STEEL
GAUGE	3
FINISH	N/P

SMP

PIN SAFE BLANKS

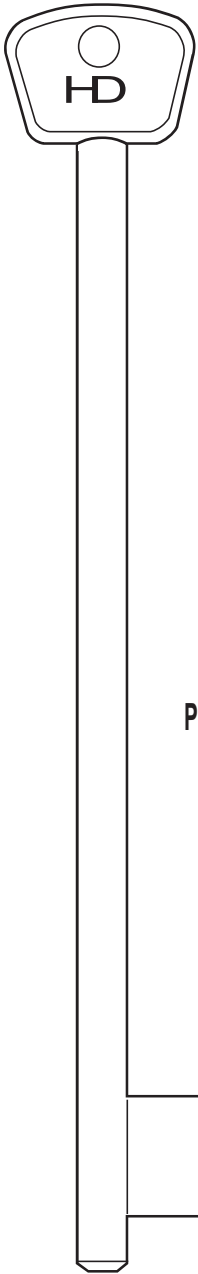

SECURITY
PROCEDURES
APPLY

For SMP 5"



KBSMP2

L324

MATERIAL	STEEL
GAUGE	3
FINISH	N/P

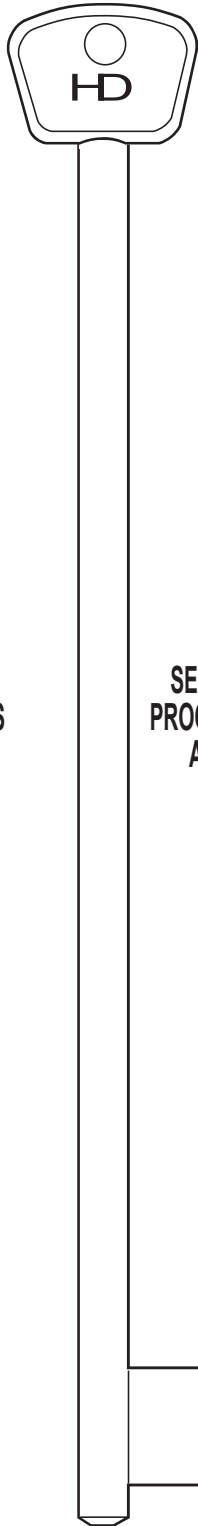

SECURITY
PROCEDURES
APPLY

For SMP 6"



KBSMP1

L323

MATERIAL	STEEL
GAUGE	3
FINISH	N/P

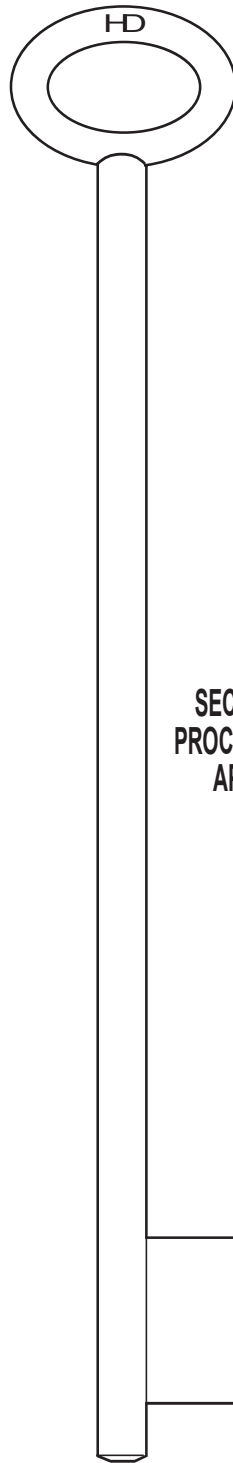

SECURITY
PROCEDURES
APPLY

Extra Long Pin Safe



307 x 3

L322

MATERIAL	STEEL
GAUGE	3
FINISH	N/P

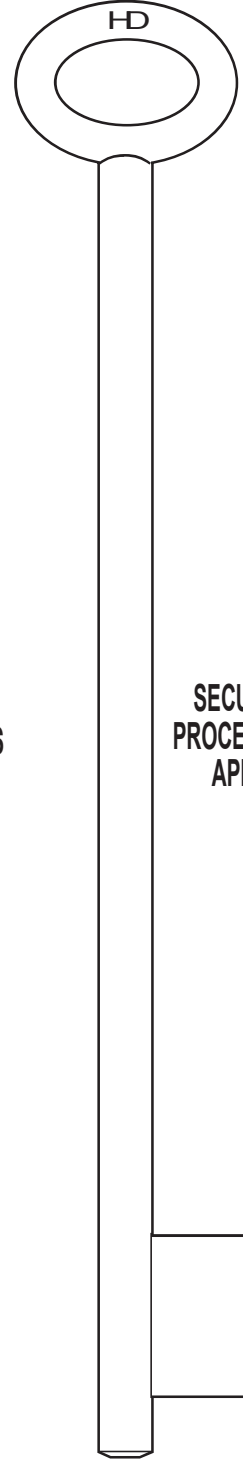

SECURITY
PROCEDURES
APPLY

Extra Long Pin Safe



307 x 2

L321

MATERIAL	STEEL
GAUGE	2
FINISH	N/P

PIN SAFE BLANKS

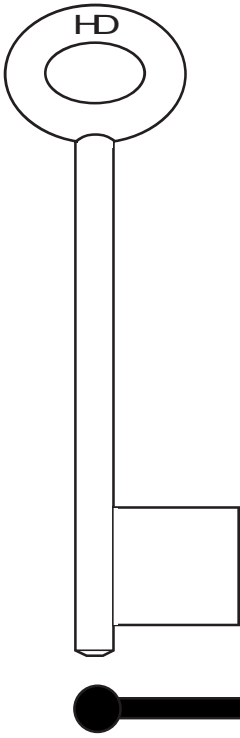

Ref No. 317 pin safe 5/8" bit

MATERIAL	STEEL
GAUGE	AS TABLE
FINISH	N/P

SECURITY PROCEDURES APPLY

GAUGE	HOOK No.
317 x 5	L210
317 x 6	L057
317 x 7	L058
317 x 8	L059

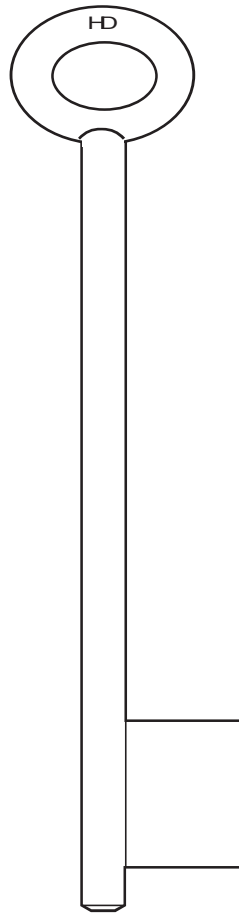

Ref No. 306 pin safe 3/4" bit

MATERIAL	STEEL
GAUGE	AS TABLE
FINISH	N/P

SECURITY PROCEDURES APPLY

GAUGE	HOOK No.
306 x 4	L204
306 x 5	L205
306 x 5.5	L206
306 x 6	L207
306 x 6.5	L208
306 x 7	L209

PIN SAFE BLANKS

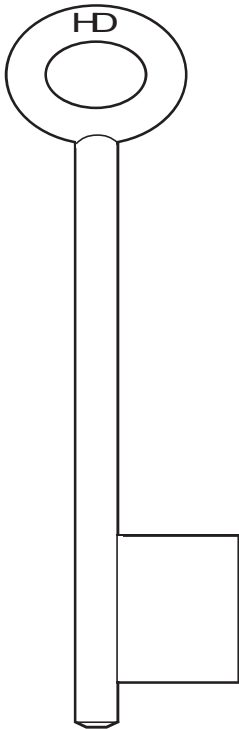

Ref No. 305 pin safe 3/4" bit

MATERIAL	STEEL
GAUGE	AS TABLE
FINISH	N/P

SECURITY PROCEDURES APPLY

GAUGE	HOOK No.
305 x 3	XL033
305 x 4	L052
305 x 5	L053
305 x 5.5	L054
305 x 6	L055
305 x 6.5	L215
305 x 7	L056
305 x 8	L281

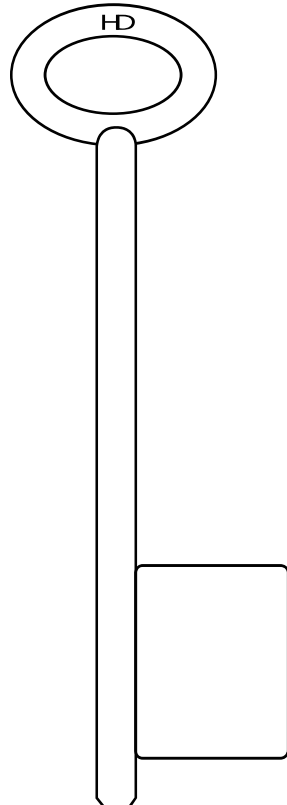

MATERIAL	STEEL
GAUGE	AS TABLE
FINISH	N/P

SECURITY PROCEDURES APPLY

GAUGE	HOOK No.
304 x 5	XL012
304 x 5.5	XL013
304 x 6	XL014
304 x 7	XL015
304 x 4.5	XL038
304 x 6.5	XL027

PIPE SAFE BLANKS

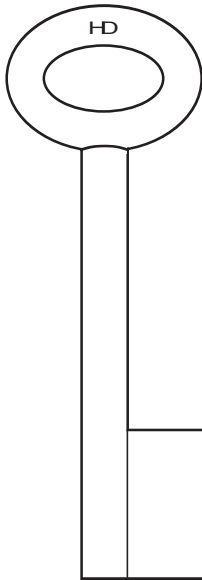

SECURITY PROCEDURES APPLY

GAUGE	HOOK No.
125 x 7	L060
125 x 8	L061
125 x 9	L062

Gauge refers to internal pipe size



Ref No. 125 pipe safe 3/4" bit

MATERIAL	STEEL
GAUGE	AS TABLE
FINISH	N/P

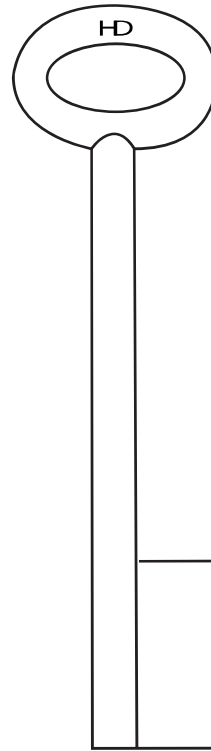

SECURITY PROCEDURES APPLY

GAUGE	HOOK No.
124 x 7	XL009
124 x 8	XL010
124 x 9	XL011



MATERIAL	STEEL
GAUGE	AS TABLE
FINISH	N/P

PIPE SAFE BLANKS

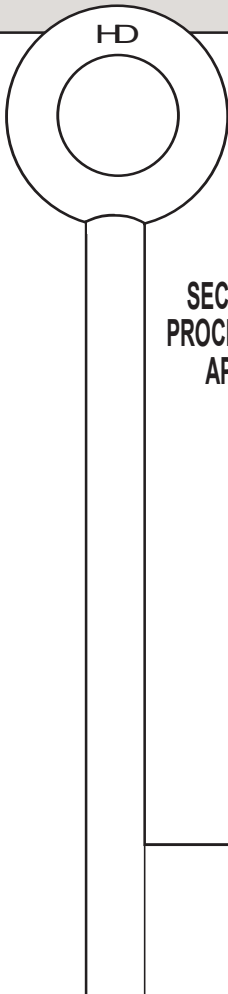

SECURITY PROCEDURES APPLY

Heavy Pipe Safe



126 x 6

L315

MATERIAL	STEEL
GAUGE	6 PIPE
FINISH	N/P

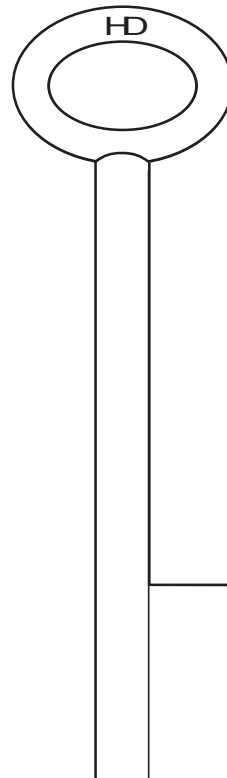

SECURITY PROCEDURES APPLY

1" bit Pipe Safe



127 x 6

L327

AGA

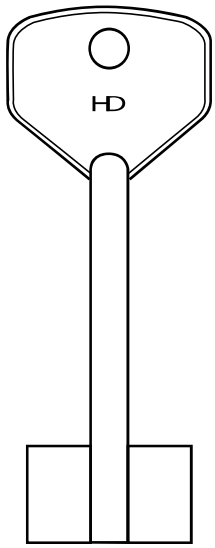

AGA-9G
XDB058

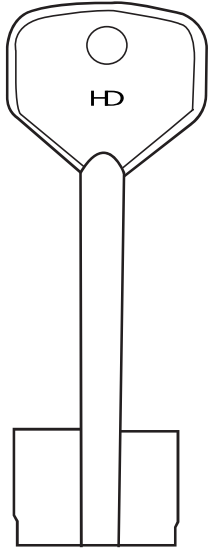

AGA-11G
XDB059

ALPHA

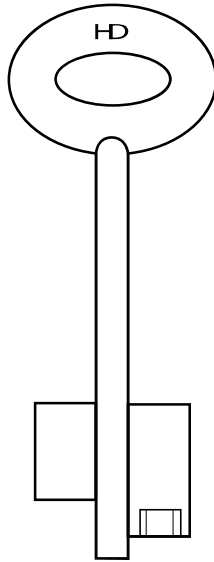

APS1
XDB046

ATRA

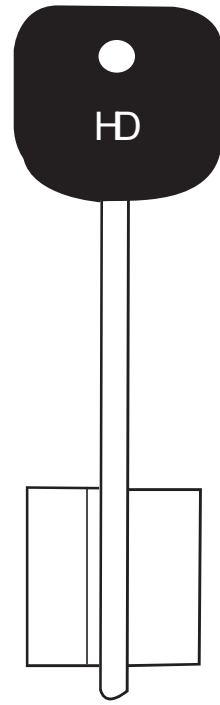

1ATP
XDB056

BETA

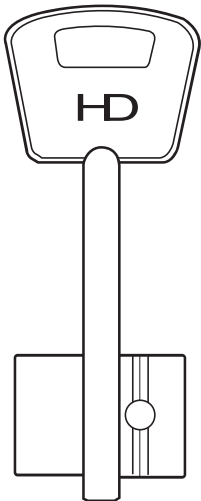

**SECURITY
PROCEDURES
APPLY**



BES
XDB018

BODA

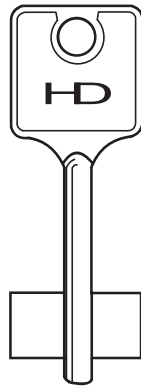

**SECURITY
PROCEDURES
APPLY**



5BDE1
XDB045

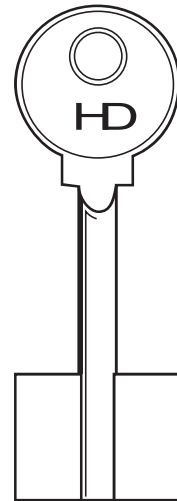

5BDE3
XDB040

CAF

CHUBB

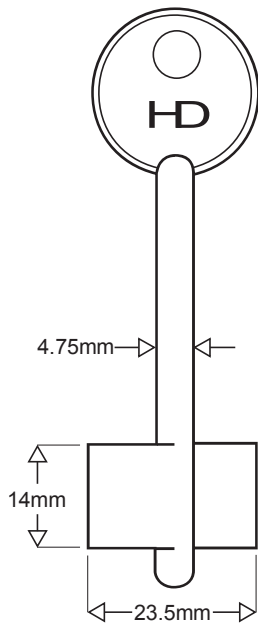

SECURITY PROCEDURES APPLY



CF
XDB003

SECURITY PROCEDURES APPLY

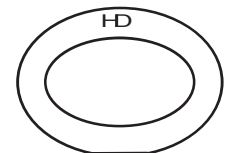
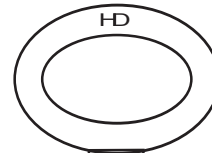

7mm

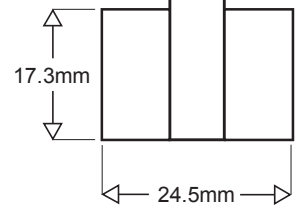

SCL1
XDB022
9G Pipe

CHATWOOD MILNER

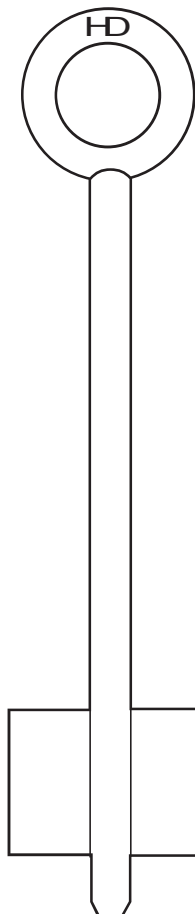

SECURITY PROCEDURES APPLY

For Chatwood Milner



KBCM
L310

MATERIAL	BRASS
GAUGE	5
FINISH	N/P

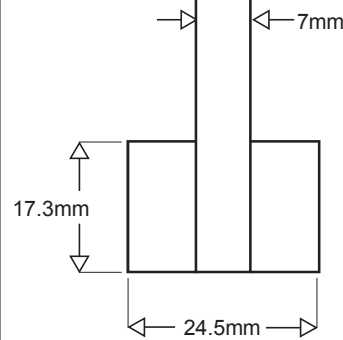

LCL1
XDB021
9G Pipe

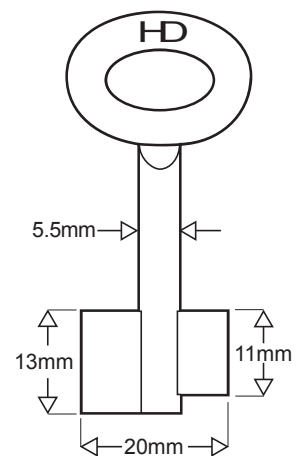

10G PIPE
8953
XDB001
CHUBB / LIPS

DUDLEY FAC FIAM IDM

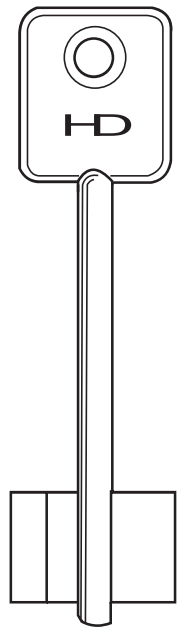
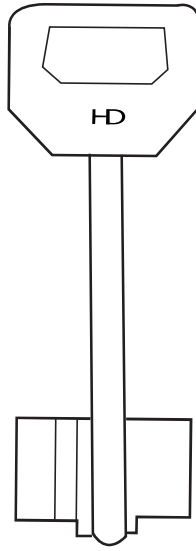
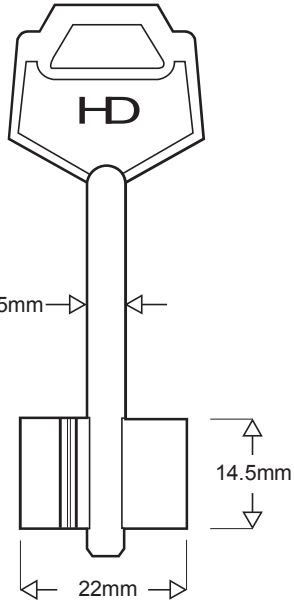
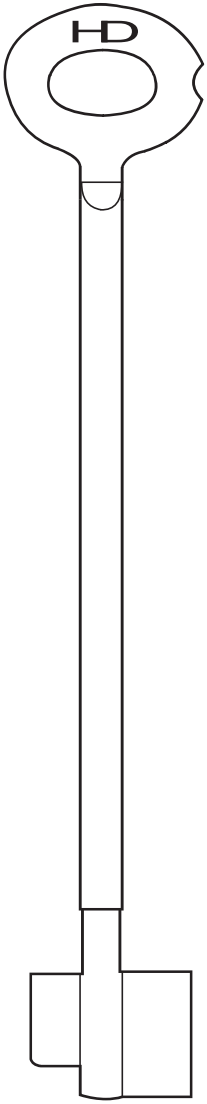

5FAC3
XDB014



5FI5
XDB055



5ID3
XDB044

JUWEL

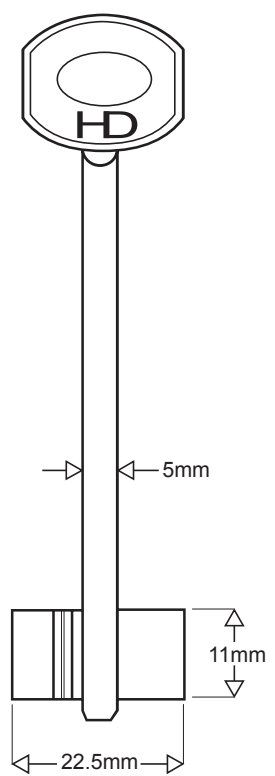
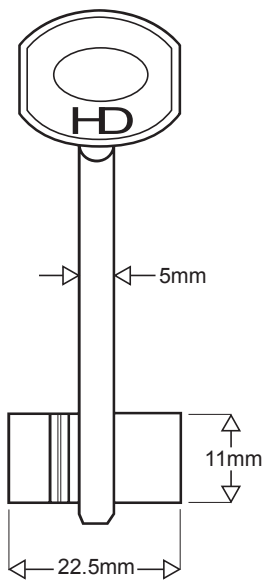
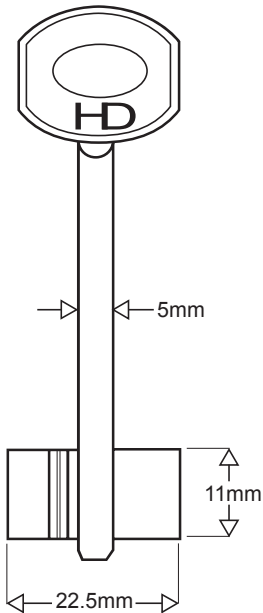

JW40
XDB008



JW35
XDB018



JW60
XDB009

4.5 Gauge



MD145
XDB034

JUWEL

KROMER

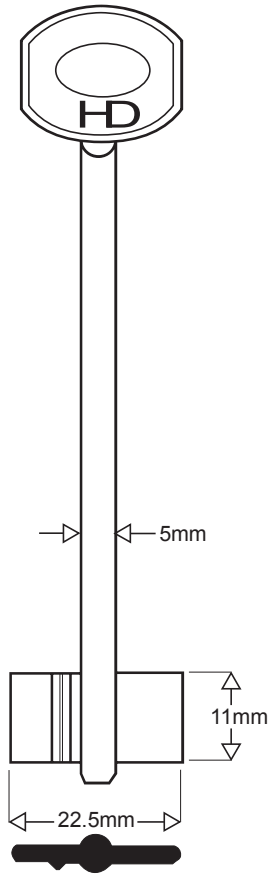

JW70
XDB010

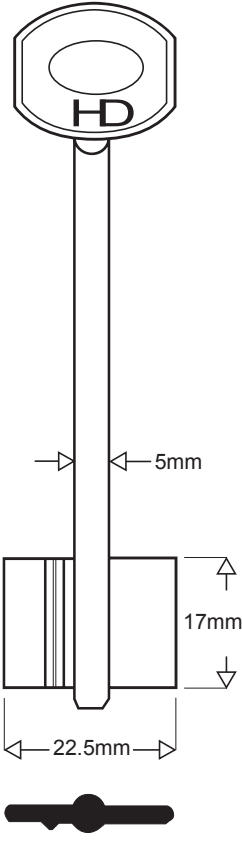

JW90
XDB011

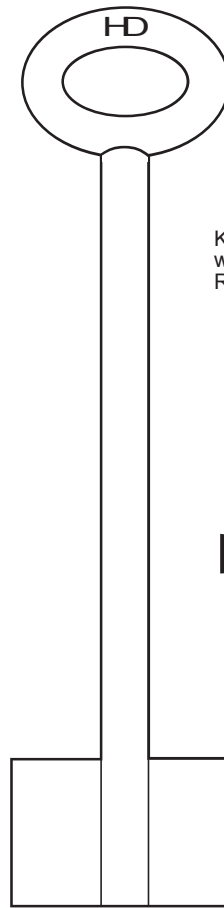

**SECURITY
PROCEDURES
APPLY**

Key blanks supplied
with smallest gauge.
Re-drill as necessary.

For Kromer



KBKR

L311

MATERIAL	BRASS
GAUGE	8 PIPE
FINISH	N/P

LIPS/VAGO

LOWE & FLETCHER

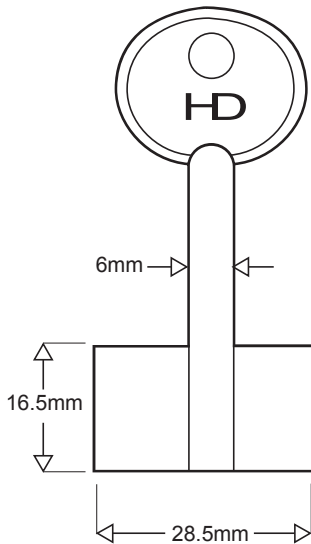

10g Pipe



5LV1
XDB007

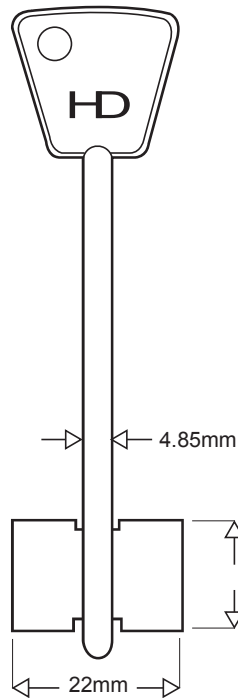

LFDB1
XDB016

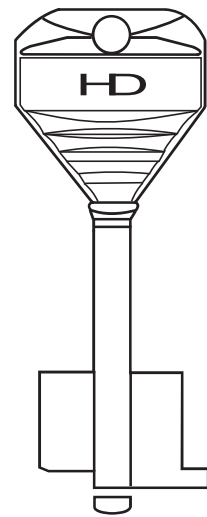

5 Gauge



LF65PN
XDB051



LF65PP
XDB036

LOWE & FLETCHER

DOUBLE BIT & SAFE

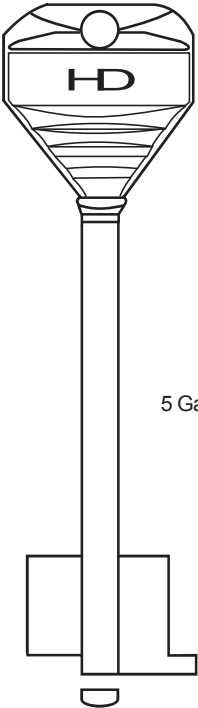

5 Gauge

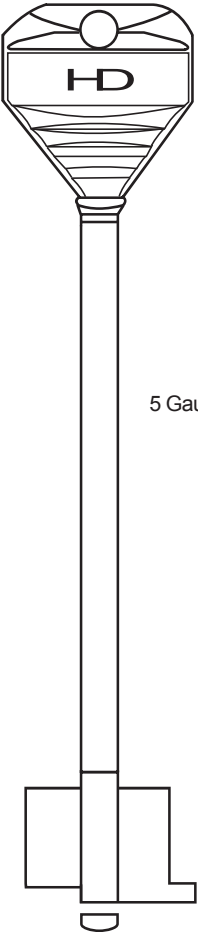

5 Gauge

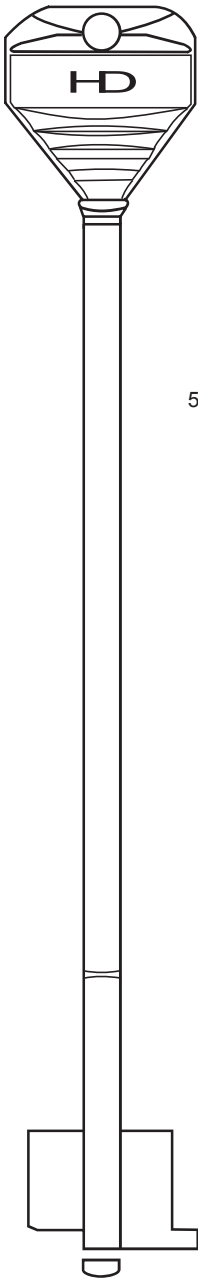

5 Gauge

PIN



LF90PN

XDB052

PIN



LF120PN

XDB053

PIN



LF165PN

XDB054

PIPE



LF90PP

XDB037

PIPE



LF120PP

XDB038

PIPE



LF165PP

XDB039

MAUER

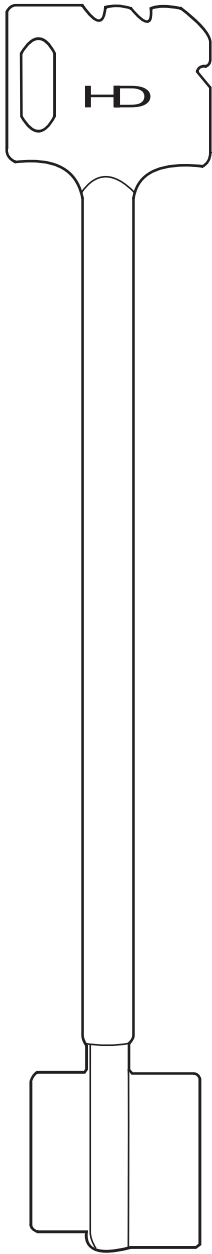

10 Gauge



88801
XDB029

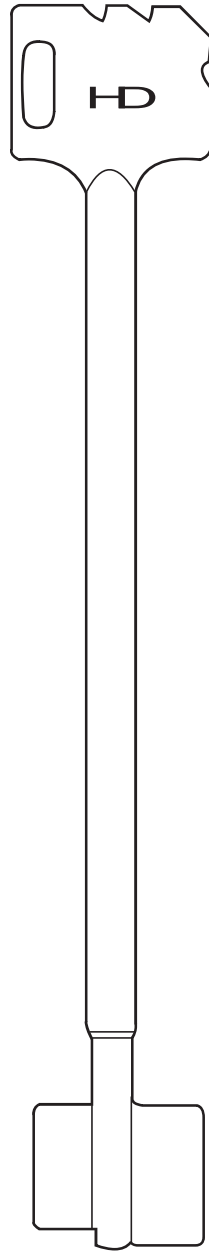

10 Gauge



88802
XDB030

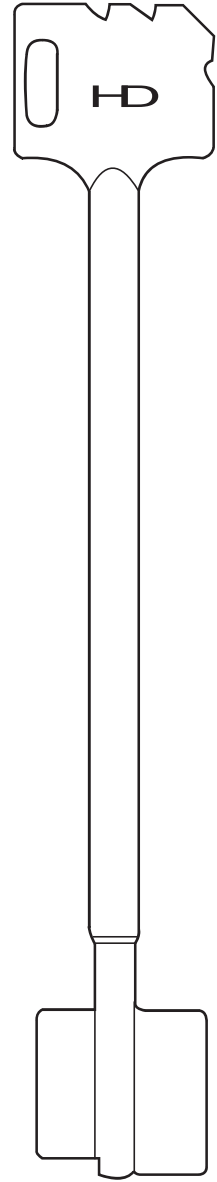

10 Gauge



88805
XDB066

MAUER

DOUBLE BIT & SAFE

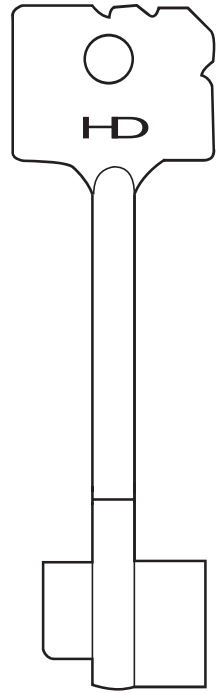
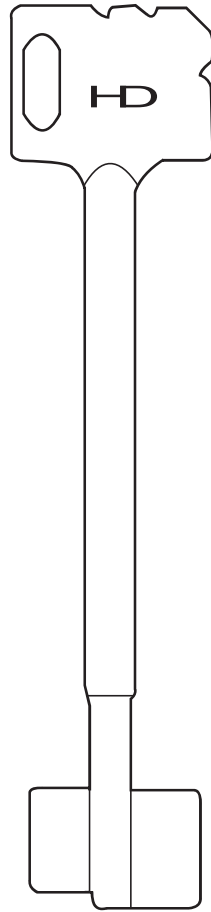
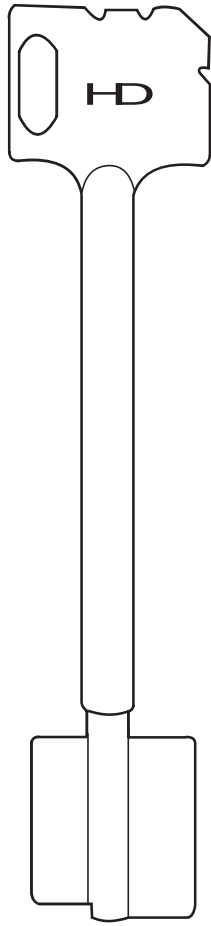
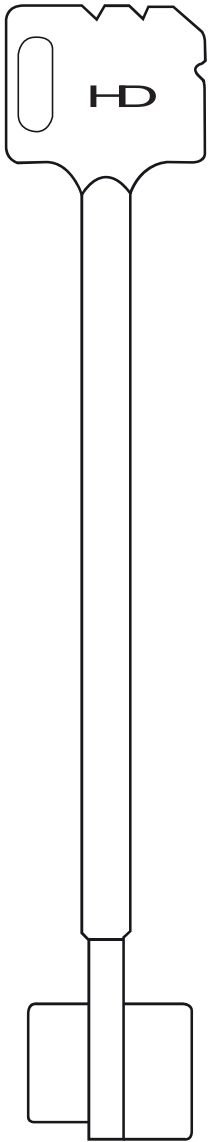

10 Gauge

10 Gauge

10 Gauge

10 Gauge



88806

88812

88813

88827

XDB065

XDB031

XDB032

XDB033

MAUER

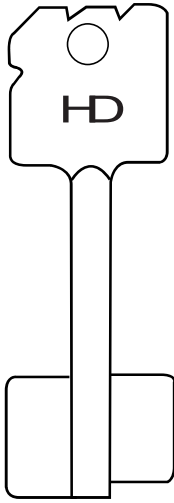

10 Gauge

88845
XDB060

MELSMETALL

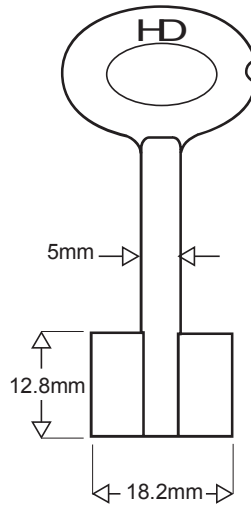

11g Pipe

5ME1
XDB012

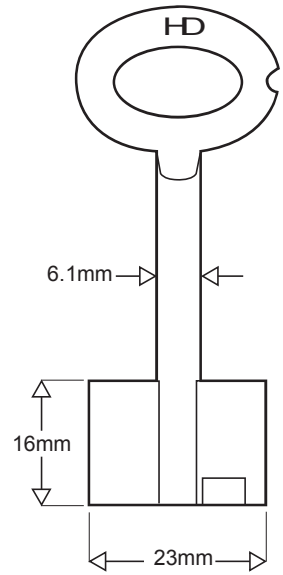

10g Pipe

5ME2
XDB013

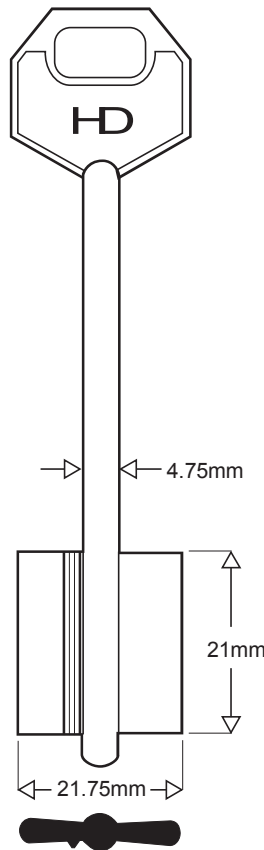
MOTTURA

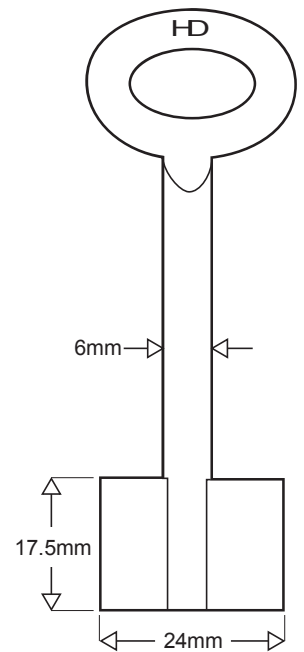

5MT9
XDB006

PARMA-PAS



9G PIPE

8980
XDB002

PREFER

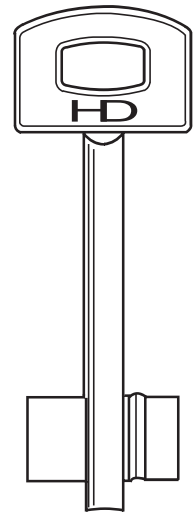
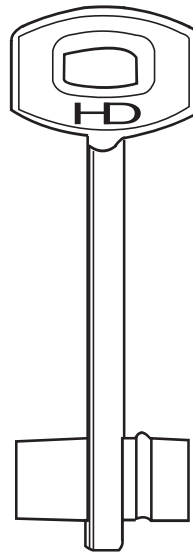
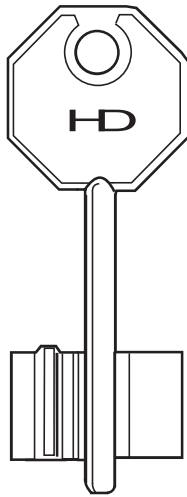
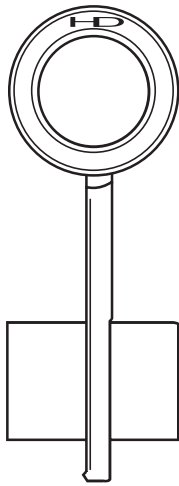
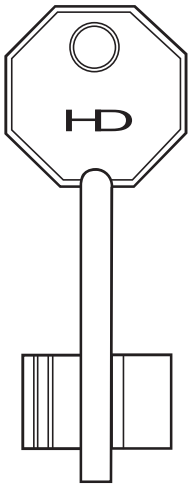
SECUR-EMME



5PT3
XDB041

PFM
XDB048

5PT13
XDB043

5SCM2
XDB042

5SCM10
XDB027

SIAS

TANN

UTILITY BLANK

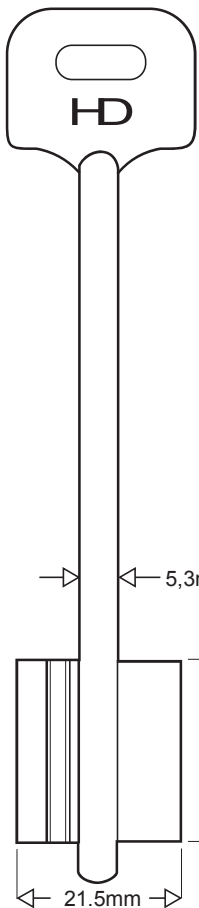

5SAS3
XDB026

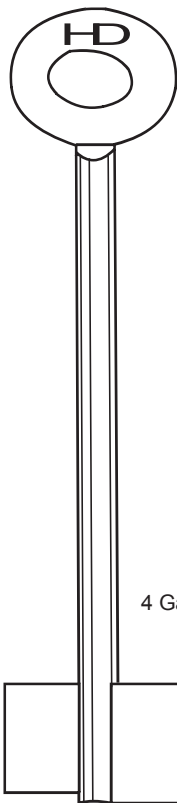

8310TA
XDB049

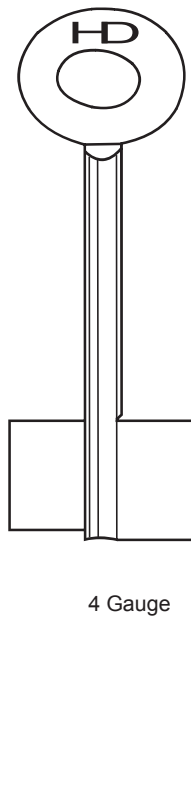

8372TA
XDB050

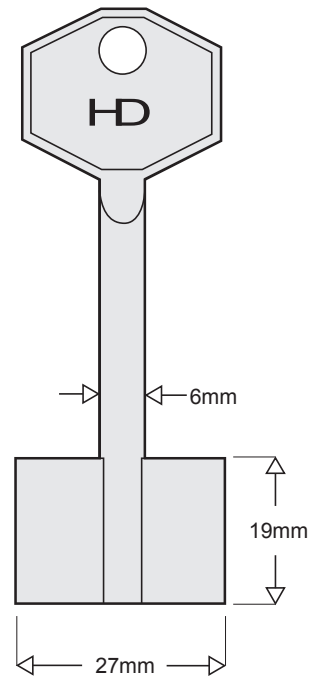

101G
XDB020